

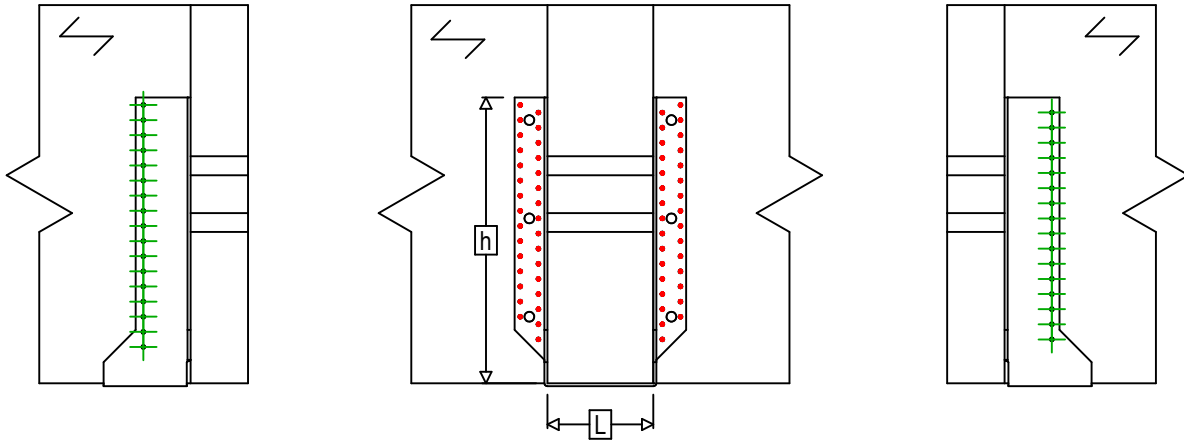

Produkt	=	GSE900AL	
Łączniki	=	Drewno - drewno	Belka - belka
Typ montażu	=	Pełne gwoździowanie	

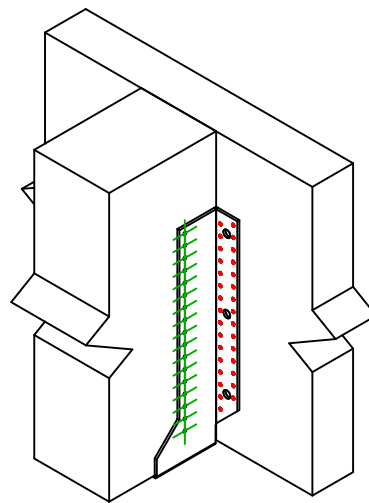

$$h = (900 - L) / 2$$



Łączniki belka główna	Symbol	Łączniki	Łączniki		Szt.	
		CNA		CNA4.0X35 / CNA4.0X50		62
		CSA		CSA5.0X35 / CSA5.0X40		
-		-	-			
Łączniki belka drugorzędna	Symbol	Łączniki	L < 64mm	L > 64mm	Szt.	
		CNA		CNA4.0X35	CNA4.0X50	33
		CSA		CSA5.0X35	CSA5.0X40	