

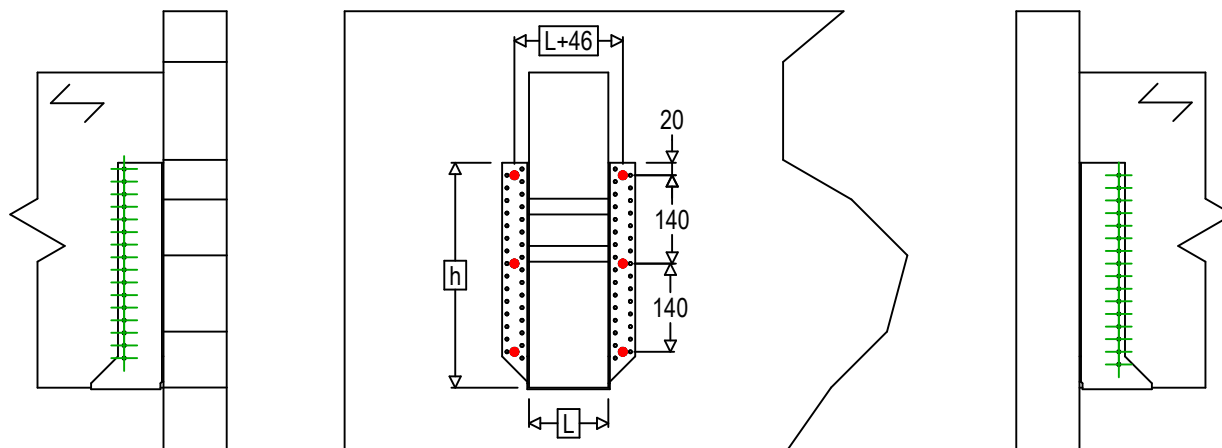

Produkt	=	GSE840	
Łączniki	=	Drewno do sztywnej podpory	Belka - belka
Typ montażu	=	Mocowanie do sztywnej podpory	

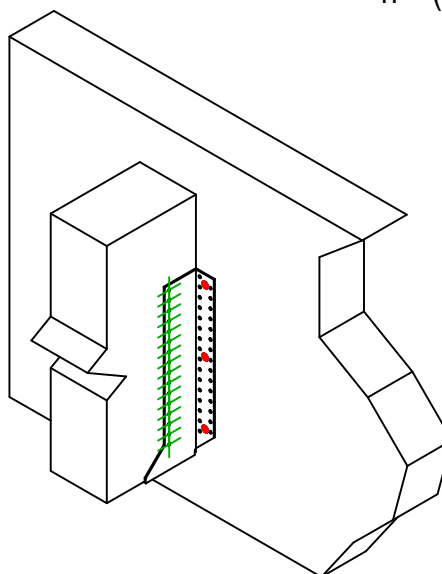

$$h = (840 - L) / 2$$



Łączniki belka główna	Symbol	Łączniki	Łączniki		Szt.	
		FM753	FM 753 EVO M12X104/5			6
		LMAS	LMASM12			
THD		THD10080				
Łączniki belka drugorzędna	Symbol	Łączniki	L < 64mm	L > 64mm	Szt.	
		CNA	CNA4.0X35	CNA4.0X50	32	
		CSA	CSA5.0X35	CSA5.0X40		