

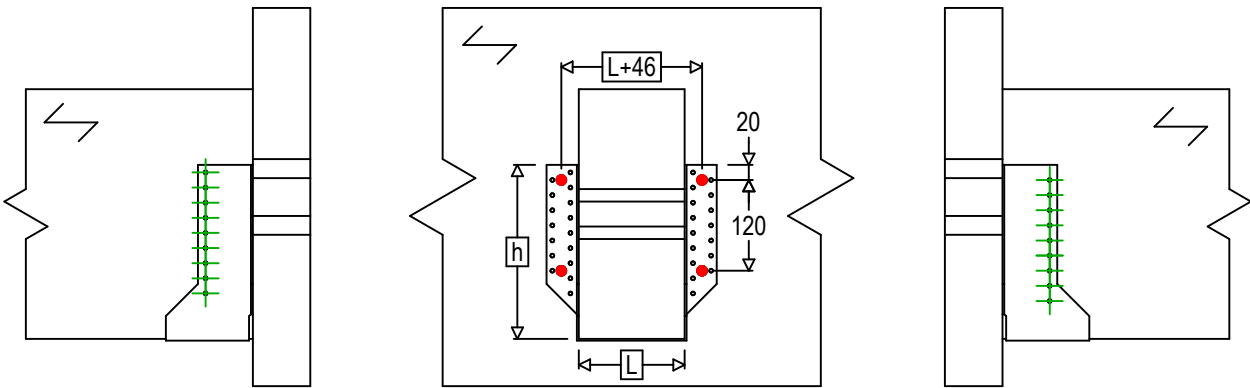

Produkt	=	GSE600AL	
Łączniki	=	Drewno - drewno	Belka - belka
Typ montażu	=	Montaż wkrętami SSH	

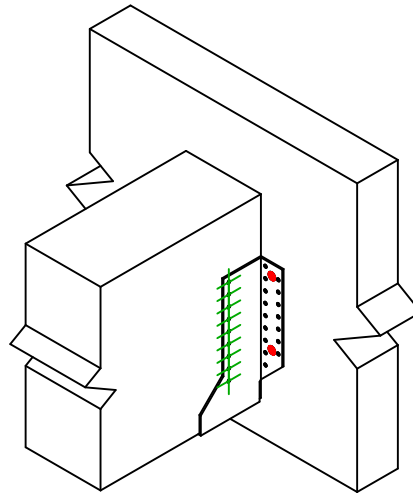

$$h = (600 - L) / 2$$



Łączniki belka główna	Symbol	Łączniki	Łączniki		Szt.
		SSH	SSH12.0X60		4
		-	-		
-		-			
Łączniki belka drugorzędna	Symbol	Łączniki	L < 64mm	L > 64mm	Szt.
		CNA	CNA4.0X35	CNA4.0X50	18
		CSA	CSA5.0X35	CSA5.0X40	