

Centre Scientifique et  
Technique du Bâtiment

84 avenue Jean Jaurès  
CHAMPS-SUR-MARNE  
F-77447 Marne-la-Vallée Cedex 2

Tél. : (33) 01 64 68 82 82  
Fax : (33) 01 60 05 70 37

**European Technical  
Assessment**

**ETA-14/0383  
of 13/10/2014**

*English translation prepared by CSTB - Original version in French language*

**General Part**

**Technical Assessment Body issuing the ETA and designated according to Article 29 of the Regulation (EU) No 305/2011:**

Nom commercial  
*Trade name*

**AT-HP**

Famille de produit  
*Product family*

**Cheville à scellement de type "à injection" pour fixation dans le béton non fissuré M8 à M30.**

***Bonded injection type anchor for use in non-cracked concrete: sizes M8 to M30***

Titulaire  
*Manufacturer*

**Simpson Strong-Tie<sup>®</sup>**  
**ZAC. Les 4 chemins**  
**85400 Sainte-Gemme-la-Plaine**  
**France**

Usine de fabrication  
*Manufacturing plant*

**Simpson Strong-Tie Manufacturing Facilities**

Cette évaluation contient:  
*This Assessment contains*

17 pages incluant 13 annexes qui font partie intégrante de cette évaluation

*17 pages including 13 annexes which form an integral part of this assessment*

Base de l'ETE  
*Basis of ETA*

ETAG 001, Version April 2013, utilisée en tant que EAD  
*ETAG 001, Edition April 2013 used as EAD*

Cette évaluation remplace:  
*This Assessment replaces*

*Translations of this European Technical Assessment in other languages shall fully correspond to the original issued document and should be identified as such. Communication of this European Technical Assessment, including transmission by electronic means, shall be in full. However, partial reproduction may be made, with the written consent of the issuing Technical Assessment Body. Any partial reproduction has to be identified as such.*

## 1 Technical description of the product

The Simpson Strong-Tie<sup>®</sup> AT-HP injection system is a bonded anchor (injection type) consisting of a mortar cartridge with injection mortar AT-HP and a steel element (threaded rod).

The steel element can be made of zinc plated carbon steel, stainless steel, or high corrosion resistant stainless steel.

The steel element is placed into a rotary/percussion drilled hole filled with the injection mortar and is anchored via the bond between the metal part and concrete.

The illustration and the description of the product are given in Annexes A.

## 2 Specification of the intended use

The performances given in Section 3 are only valid if the anchor is used in compliance with the specifications and conditions given in Annexes B.

The provisions made in this European Technical Assessment are based on an assumed working life of the anchor of 50 years. The indications given on the working life cannot be interpreted as a guarantee given by the producer, but are to be regarded only as a means for choosing the right products in relation to the expected economically reasonable working life of the works.

## 3 Performance of the product

### 3.1 Mechanical resistance and stability (BWR 1)

Essential characteristic	Performance
Characteristic tension resistance and shear resistance for threaded rods acc. TR029	See Annex C1, C2
Characteristic tension resistance and shear resistance for threaded rods acc. CEN/TS 1992-4-5	See Annex C3, C4
Displacements	See Annex C5

### 3.2 Safety in case of fire (BWR 2)

Essential characteristic	Performance
Reaction to fire	Anchorage satisfy requirements for Class A1
Resistance to fire	No performance determined (NPD)

### 3.3 Hygiene, health and the environment (BWR 3)

Regarding dangerous substances contained in this European Technical Assessment, there may be requirements applicable to the products falling within its scope (e.g. transposed European legislation and national laws, regulations and administrative provisions). In order to meet the provisions of the Construction Products Directive, these requirements need also to be complied with, when and where they apply.

### 3.4 Safety in use (BWR 4)

For Basic Requirement Safety in use the same criteria are valid as for Basic Requirement Mechanical Resistance and Stability.

### 3.5 Protection against noise (BWR 5)

Not relevant.

**3.6 Energy economy and heat retention (BWR 6)**

Not relevant.

**3.7 General aspects relating to fitness for use**

Durability and Serviceability are only ensured if the specifications of intended use according to Annex B1 are kept.

**4 Assessment and Verification of Constancy of Performance (AVCP)**

According to the Decision 96/582/EC of the European Commission<sup>1</sup>, as amended, the system of assessment and verification of constancy of performance (see Annex V to Regulation (EU) No 305/2011) given in the following table apply.

Product	Intended use	Level or class	System
Metal anchors for use in concrete	For fixing and/or supporting to concrete, structural elements (which contributes to the stability of the works) or heavy units	—	1

**5 Technical details necessary for the implementation of the AVCP system**

Technical details necessary for the implementation of the Assessment and verification of constancy of performance (AVCP) system are laid down in the control plan deposited at Centre Scientifique et Technique du Bâtiment.

The manufacturer shall, on the basis of a contract, involve a notified body approved in the field of anchors for issuing the certificate of conformity CE based on the control plan.

Issued in Marne La Vallée on 13-10-2014 by  
Charles Baloche  
Directeur technique

*The original French version is signed*

---

<sup>1</sup> Official Journal of the European Communities L 254 of 08.10.1996

## Simpson Strong-Tie® AT-HP Injection Mortar

Cartridge: 160ml, 170ml, 280ml, 300ml, 345ml, 380ml, 825ml



Imprints:  
 Commercial name,  
 Manufacturer identification,  
 Installation instructions,  
 Expiration date, Batch-no.,  
 Hazard codes

Mixing nozzle «MN1»



Threaded rod: M8, M10, M12, M16, M20, M24, M27 or M30

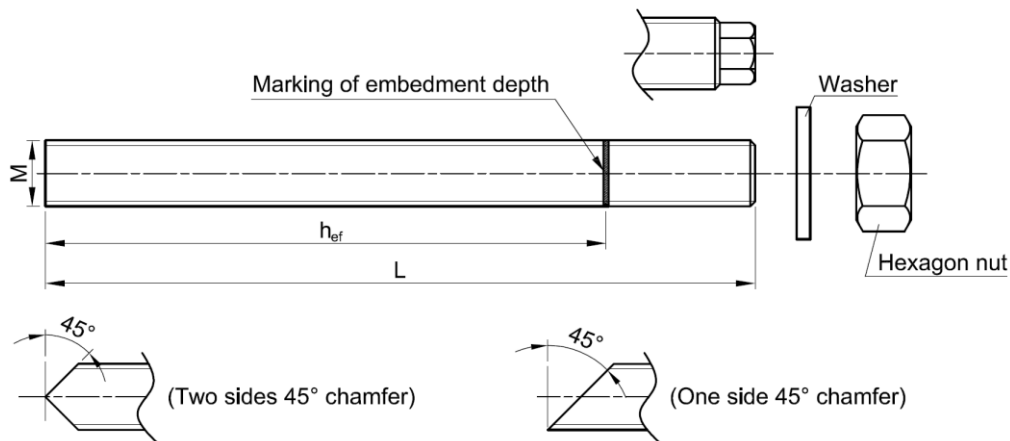

### Installation

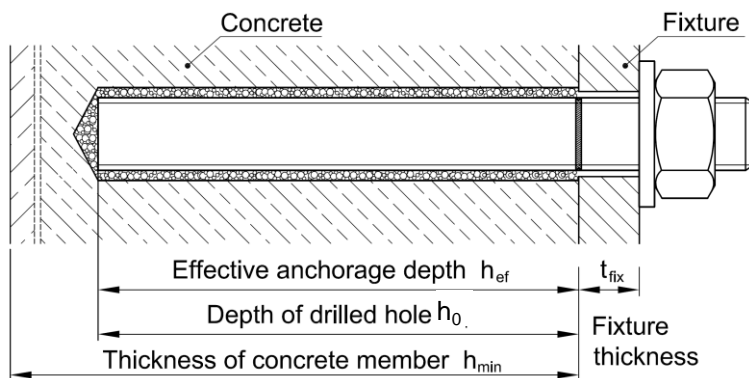

**Simpson Strong-Tie®  
 AT-HP Injection Mortar**

System Description and installation

Annex A1

**Simpson Strong-Tie®  
 AT-HP Injection Mortar**

**Table A1: Materials (Threaded rod)**

Designation	Material
Steel, zinc plated $\geq 5\mu\text{m}$ according EN ISO 4042 (A2), Steel, hot dipped galvanized $> 40\mu\text{m}$ EN ISO 10684	
Threaded rod	Carbon steel: Property class 5.8, 8.8 and 10.9 acc. EN ISO 898-1; A5 $\geq 8\%$ ductile
Washer	Steel: EN ISO 7089 (DIN 125), EN ISO 7094 (DIN 440), EN ISO 7093 (DIN 9021)
Hexagon nut	Steel: EN ISO 4032 (DIN 934), property class 8 or classe 10 acc. EN ISO 898-2
<b>Stainless steel</b>	
Threaded rod	Stainless steel: 1.4362; 1.4401; 1.4404; 1.4439; 1.4571; 1.4578 acc. EN 10088 $\leq$ M24: Property class 70 acc. EN ISO 3506-1; A5 $\geq 8\%$ ductile $>$ M24: Property class 50 acc. EN ISO 3506-1; A5 $\geq 8\%$ ductile
Washer	EN ISO 7089 (DIN 125); EN ISO 7094 (DIN 440), EN ISO 7093 (9021) Stainless steel: 1.4362; 1.4401; 1.4404; 1.4439; 1.4571; 1.4578 acc. EN 10088
Hexagon nut	EN ISO 4032 (DIN 934) $\leq$ M24: Property class 70 acc. EN ISO 3506-2; $>$ M24: Property class 50 or 70 acc. EN ISO 3506-2; Stainless steel: 1.4362; 1.4401; 1.4404; 1.4439; 1.4571; 1.4578 acc. EN 10088
<b>Stainless steel - High corrosion resistant steel</b>	
Threaded rod	Stainless steel 1.4529, 1.4565 acc. EN 10088 $\leq$ M24: $R_m = 700 \text{ N/mm}^2$ ; $R_{p0.2} = 450 \text{ N/mm}^2$ ; A5 $\geq 8\%$ ductile; EN ISO 3506-1 $>$ M24: $R_m = 500 \text{ N/mm}^2$ ; $R_{p0.2} = 210 \text{ N/mm}^2$ ; A5 $\geq 8\%$ ductile; EN ISO 3506-1
Washer	ISO 7089 (DIN 125), EN ISO 7094 (DIN 440), EN 7093 (DIN 9021) Stainless steel: 1.4529, 1.4565 acc. EN 10088
Hexagon nut	EN ISO 4032 (DIN 934) Strength class 70 acc. EN ISO 3506-2 Stainless steel: 1.4529, 1.4565 acc. EN 10088
<b>Commercial threaded rods with:</b>	
Inspection certificate 3.1 according to EN 10204: 2004	
Marking of embedment depth (This may be done by the manufacturer of the rod or by the worker on jobsite)	



**Simpson Strong-Tie®  
 AT-HP Injection Mortar**

**Annex A2**

**Materials : Threaded rod**

### Specifications of intended use

**Table B1: Overview use categories and performance categories**

Use conditions	Simpson Strong-Tie® AT-HP with ...
	<b>Threaded rods</b> 
hammer drilling or compressed air drilling mode. 	✓
Static and quasi static loading, in non-cracked concrete	M8 to M30 Table C1, C2, C3, C4, C5
Use category: dry or wet concrete	✓
Installation temperature	Standard pack : mortar +5°C, concrete -5°C Winter pack : mortar 0°C, concrete -15°C
In-service temperature	Temperature range I: -40°C to +40°C (max long term temperature +24°C and max short term temperature +40°C)
	Temperature range II: -40°C to +80°C (max long term temperature +50°C and max short term temperature +80°C)

**Base materials:**

- Reinforced or unreinforced normal weight concrete according to EN 206-1:2000-12.
- Strength classes C20/25 to C50/60 according to EN 206-1:2000-12.
- Maximum chloride concrete of 0,40% (CL 0.40) related to the cement content according to EN 206-1:2000-12.

**Use conditions (Environmental conditions):**

- Structures subject to dry internal conditions (zinc coated steel, stainless steel or high corrosion resistant steel).
- Structures subject to external atmospheric exposure including industrial and marine environment (stainless steel or high corrosion resistant steel).
- Structures subject to permanently damp internal condition, if no particular aggressive conditions exist (stainless steel or high corrosion resistant steel).  
*Note: Particular aggressive conditions are e.g. permanent, alternating immersion in seawater or the splash zone of seawater, chloride atmosphere of indoor swimming pools or atmosphere with extreme chemical pollution (e.g. in desulphurization plants or road tunnels where de-icing materials are used).*
- Overhead installations are permitted

**Design:**

- Anchorages are designed under the responsibility of an engineer experienced in anchorages and concrete work.
- Verifiable calculation notes and drawings are prepared taking account of the forces to be transmitted. The position of the anchor is indicated on the design drawings (e. g. position of the anchor relative to reinforcement or to supports, etc.).
- Anchorages under static or quasi-static actions are designed in accordance with (please choose the relevant design method): EOTA Technical Report TR 029, Edition September 2010; CEN/TS 1992-4-5

<b>Simpson Strong-Tie®                  AT-HP Injection Mortar</b>	<b>Annex B1</b>
<b>Intended use - Specifications</b>	

**Table B2: Installation data for threaded rod**

Simpson Strong-Tie® AT-HP Injection Mortar			Threaded rod							
			M8	M10	M12	M16	M20	M24	M27	M30
Nom. threaded rod diameter	d	[mm]	8	10	12	16	20	24	27	30
Drill hole diameter	d <sub>o</sub>	[mm]	10	12	14	18	22	28	30	35
Embedment depth and drill hole depth	h <sub>ef, min</sub>	[mm]	60	60	70	80	90	96	108	120
	h <sub>ef, max</sub>		160	200	240	320	400	480	540	600
Diameter of clearance hole in the fixture <sup>1)</sup>	d <sub>f</sub> ≤	[mm]	9	12	14	18	22	26	30	33
Installation torque	T <sub>inst,max</sub>	[Nm]	10	20	40	80	150	200	270	300
Minimum thickness of concrete member	h <sub>min</sub>	[mm]	h <sub>ef</sub> +30 mm ≥ 100 mm				h <sub>ef</sub> + 2d <sub>o</sub>			
Minimum allowable spacing	s <sub>min</sub>	[mm]	40	50	60	80	100	120	135	150
Minimum allowable edge distance	c <sub>min</sub>	[mm]	40	50	60	80	100	120	135	150

<sup>1)</sup> for larger clearance hole in the fixture see TR 029 section 1.1 and/or CEN/TS 1992-4-1:2009, section 1.2.3

**Simpson Strong-Tie®  
 AT-HP Injection Mortar**

**Installation data**

**Annex B2**

### Installation instructions

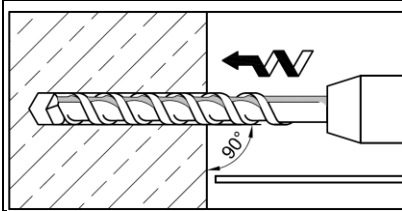

Drill hole to the required embedment depth ( $h_{ef}$ ) with a hammer drill using specified carbide drill bit diameter ( $d_0$ ).

#### a.) Manual Cleaning

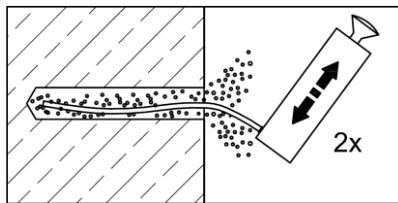

The manual pump can be used up to drill holes  $\leq \varnothing 22$  mm and embedment depths up to  $h_{ef} \leq 10d$ .

Blow out dust from the hole 2 times with manual pump starting from the bottom of the hole.

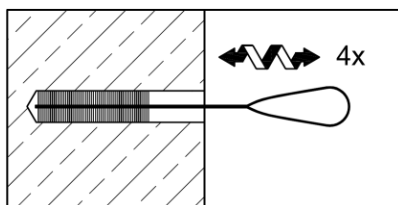

Brush 4 times with specified brush size (brush diameter  $\geq$  drill hole diameter  $d_0$ ) by inserting the brush to the bottom of the hole with a twisting motion and removing. The brush shall have a resistance as it enters the drilled hole. If this is not the case a new brush shall be used.

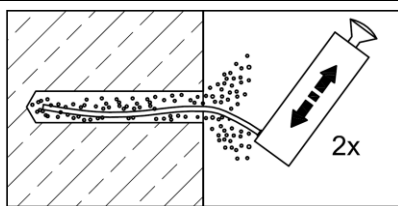

Finally blow out dust from hole 2 times with manual pump starting from the bottom of the hole until return air stream is free of noticeable dust.

#### b.) Compressed air cleaning (CAC) for drilled holes $> \varnothing 22$ mm or $h_{ef} \geq 10d$

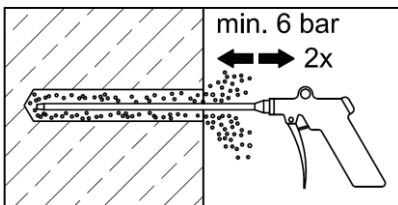

For larger drilled holes  $> \varnothing 22$  mm or  $h_{ef} \geq 10d$ , compressed air (min. 6 bar) shall be used.

Blow out dust from the hole 2 times with oil-free compressed air (min. 6 bar) starting from the bottom of the hole.

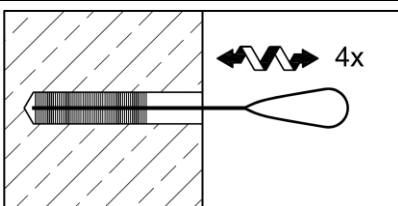

Brush 4 times with specified brush size (brush diameter  $\geq$  drill hole diameter  $d_0$ ) by inserting the brush to the bottom of the hole with a twisting motion and removing. The brush shall have a resistance as it enters the drilled hole. If this is not the case a new brush shall be used.

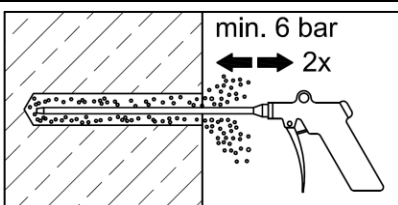

Finally blow out dust from the hole 2 times with oil-free compressed air (min. 6 bar) starting from the bottom of the hole until return air stream is free of noticeable dust. If required use additional accessories and extensions for air nozzle to reach the bottom of the hole.

**Simpson Strong-Tie®**  
**AT-HP Injection Mortar**

**Installation instruction I**

**Annex B3**



### Installation instructions

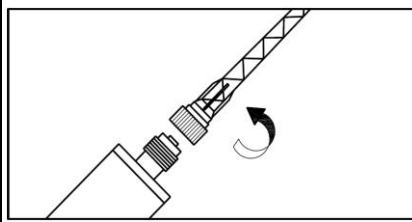

Check cartridge expiration date. Do not use expired products.  
 Attach the static-mixing nozzle supplied by the manufacturer to the cartridge.

Using foil pack cartridges: Cutting open the foil pack

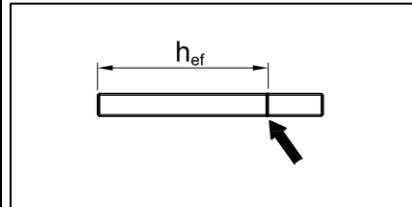

Before setting the threaded rod into the filled drill hole, mark the required embedment depth on the anchor rod.

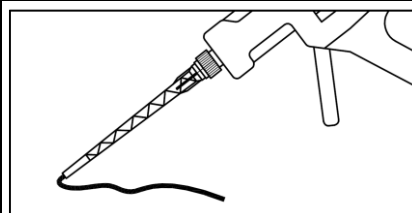

Dispense adhesive to the side until properly mixed (uniform color).  
 (3 pressures at least)

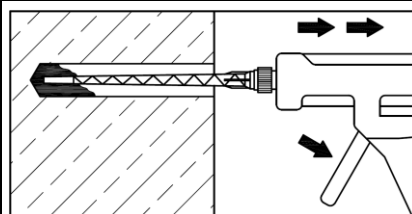

Fill up the hole approximately 2/3rd with mortar starting from the bottom of the cleaned drilled hole. Withdraw the nozzle slowly step by step after each trigger to avoid creating air pockets.

For drill holes deeper than 150 mm an extension tube shall be used.

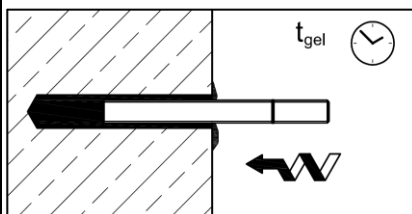

Insert a clean, oil free threaded rod, turning slowly until the stud contacts the bottom of the hole or until to the marking of  $h_{ef}$ . After installing the stud the annular gap must be completely filled with adhesive mortar.

Setting control: After the stud has been fully inserted until the marking of embedment depth, excess mortar flows out of the drilled hole.

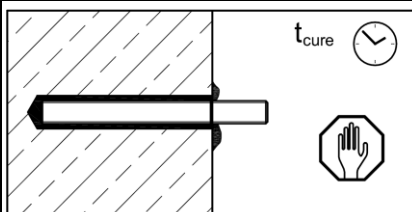

Do not disturb the threaded rod until fully cured.

The curing time  $t_{cure}$  is given in Table B3.

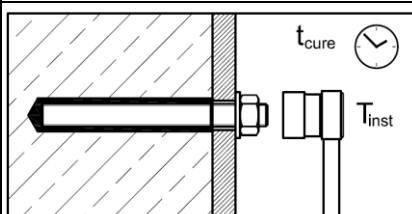

After required curing time, the anchor can be loaded. Apply the installation torque  $T_{inst}$  using calibrated torque wrench.

**Simpson Strong-Tie®**  
**AT-HP Injection Mortar**

**Annex B3**

**Installation instruction II**

**Table B3: Gel time  $t_{gel}$  and minimum curing time  $t_{cure}$**

Mortar temperature C° $T_{mortar}$	Base material temperature C° $T_{base\ material}$	Gel time (working time) in dry/wet concrete $t_{gel}$	Curing time, in dry/wet concrete * $t_{cure}$
<b>Standard version</b>			
+5°C	-5 °C to -1 °C	15 min	9 h
+5°C	0 °C to 4 °C	12 min	4 h
+5°C	5 °C to 9 °C	9 min	1,5 h
+10°C	10 °C to 19 °C	4 min	60 min
+20°C	20 °C to 29 °C	1 min	30 min
+30°C	30 °C and above	< 1 min	20 min

Concerning the version of the mortar with changing color proof, after the minimum curing time the blue colored injection mortar changed into grey. The curing color proof is available for standard version of the mortar only, and the curing color proof is working above 5°C.

Mortar temperature C° $T_{mortar}$	Base material temperature C° $T_{base\ material}$	Gel time (working time) in dry/wet concrete $t_{gel}$	Curing time, in dry/wet concrete * $t_{cure}$
<b>Winter version</b>			
0°C	-15 °C to -11 °C	30 min	14 h
0°C	-10 °C to -6 °C	10 min	8 h
0°C	-5 °C to -1 °C	7 min	4 h
0°C	0 °C to 4 °C	5 min	2,5 h
+5°C	5 °C to 9 °C	3 min	1,5 h
+10°C	10 °C to 19 °C	2 min 30"	60 min
+20°C	20 °C and above	< 2 min 30"	50 min









\* Installation in water-filled holes is not allowed.

**Simpson Strong-Tie®  
 AT-HP Injection Mortar**

**Working and curing time**

**Annex B4**

**Mortar cartridges, Dispensing tools**

Name	Cartridge	Dispensing tool
Coaxial cartridge: 160/280ml		
Foil pack cartridge: 170/300ml		DT300
Side by Side cartridge: 345ml		
Coaxial cartridge: 380ml		
Side by Side cartridge: 825ml		

**Simpson Strong-Tie®  
 AT-HP Injection Mortar**

**Mortar cartridges, Dispensing tools**

**Annex B5**

**Table B4: Cleaning equipment**

Simpson Strong-Tie® AT-HP Injection Mortar		Threaded rod							
		M8	M10	M12	M16	M20	M24	M27	M30
Drill bit	Diameter $d_0$ [mm]	10	12	14	18	22	28	30	35
Cleaning brush -Nylon-	Diameter $d_b$ [mm]	12	17	17	30	30	-		
	Length $l_b$ [mm]	85	80				-		
Cleaning brush -Steel-	Diameter $d_b$ [mm]	11	13	15	20	24	30	32	37
	Length $l_b$ [mm]	80					100		

**Cleaning brush**

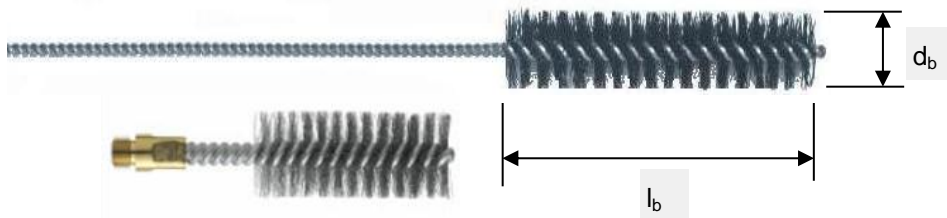

**Compressed air cleaning tool**



Air pressure : min. 6 bar ( $\geq 120$  l/min)

**Manual pump (Volume min. 750ml)**



**Extension tubes for mixing nozzle MN1:**  
 Flexible plastic hose:  $\varnothing 8,0 - \varnothing 8,5$  mm  
 Rigid plastic tube: MNE

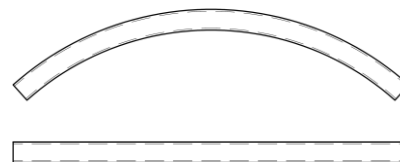

**Simpson Strong-Tie®  
 AT-HP Injection Mortar**

**Installation equipment**

**Annex B6**

**Table C1: Characteristic values of resistance to tension loads.**  
**Design method TR 029**

Simpson Strong-Tie® AT-HP Injection Mortar			Threaded rod								
			M8	M10	M12	M16	M20	M24	M27	M30	
<b>Steel failure</b>											
Characteristic resistance, Steel grade 5.8	$N_{Rk,s}$	[kN]	18.3	29	42.2	78.5	122.5	176.5	229.5	280.5	
Characteristic resistance; Steel grade 8.8	$N_{Rk,s}$	[kN]	29.3	46.4	67.4	125.6	196	282.4	367.2	448.8	
Partial safety factor	$\gamma_{Ms}^{1)}$	[-]	1.5								
Characteristic resistance; Steel grade 10.9	$N_{Rk,s}$	[kN]	36.6	58	84.3	157	245	353	459	561	
Partial safety factor	$\gamma_{Ms}^{1)}$	[-]	1.4								
Characteristic resistance, Stainless steel A4 and HCR, property class 50 (>M24) and 70 (≤M24)	$N_{Rk,s}$	[kN]	25.6	40.6	59	109.9	171.5	247.1	229.5	280.5	
Partial safety factor	$\gamma_{Ms}^{1)}$	[-]	1.87					2.86			
<b>Combined pull-out and concrete cone failure</b>											
Nom. threaded rod diameter	d	[mm]	8	10	12	16	20	24	27	30	
Characteristic bond resistance in <b>non-cracked</b> concrete C20/25											
Temperature range I: 40°C / 24°C <sup>2)</sup>	$\tau_{Rk,ucr}$	[N/mm <sup>2</sup> ]	9.0	8.5	8.5	8.0	7.5	6.5	6.5	6.0	
Temperature range II: 80°C / 50°C <sup>2)</sup>	$\tau_{Rk,ucr}$	[N/mm <sup>2</sup> ]	7.0	6.5	6.5	6.0	5.5	5.0	5.0	4.5	
Increasing factor for $\tau_{Rk}$ in non-cracked concrete	$\Psi_c$	C25/30	1.06								
		C30/37	1.12								
		C35/45	1.19								
		C40/50	1.23								
		C45/55	1.27								
		C50/60	1.30								
Partial safety factor	$\gamma_{Mp}^{1)}$ $\gamma_{Mc}$	[-]	2.1 <sup>3)</sup>					1.8 <sup>4)</sup>			
<b>Splitting failure</b>											
Edge distance $c_{cr,sp}$ [mm]	$h/h_{ef} \geq 2.0$	$1.0 h_{ef}$									
	$2.0 > h/h_{ef} > 1.3$	$4.6 h_{ef} - 1.8 h$									
	$h/h_{ef} \leq 1.3$	$2.26 h_{ef}$									
Center spacing (splitting)	$s_{cr,sp}$	[mm]	$2 \times c_{cr,sp}$								
Partial safety factor	$\gamma_{Msp}^{1)}$	[-]	2.1 <sup>3)</sup>					1.8 <sup>4)</sup>			

<sup>1)</sup> In absence of other national regulations

<sup>2)</sup> Maximum short and long term temperatures

<sup>3)</sup> The partial safety factor  $\gamma_2 = 1,4$  is included

<sup>4)</sup> The partial safety factor  $\gamma_2 = 1,2$  is included

**Simpson Strong-Tie®**  
**AT-HP Injection Mortar**

Design method TR 029:

Char. values of resistance to tension loads - Threaded rods

**Annex C1**

**Table C2: Characteristic values of resistance to shear loads.**  
**Design method TR 029**

Simpson Strong-Tie® AT-HP Injection Mortar			Threaded rod								
			M8	M10	M12	M16	M20	M24	M27	M30	
<b>Steel failure without lever arm</b>											
Characteristic resistance, Steel grade 5.8	$V_{Rk,s}$	[kN]	9.2	14.5	21.1	39.3	61.3	88.3	114.8	140.3	
Characteristic resistance; Steel grade 8.8	$V_{Rk,s}$	[kN]	14.7	23.2	33.7	62.8	98	141.2	183.6	224.4	
Partial safety factor	$\gamma_{Ms}^{1)}$	[-]	1.25								
Characteristic resistance; Steel grade 10.9	$V_{Rk,s}$	[kN]	18.3	29	42.2	78.5	122.5	176.5	229.5	280.5	
Partial safety factor	$\gamma_{Ms}^{1)}$	[-]	1.5								
Characteristic resistance, Stainless steel A4 and HCR, property class 50 (>M24) and 70 ( $\leq$ M24)	$V_{Rk,s}$	[kN]	12.8	20.3	29.5	55.0	85.8	123.6	114.8	140.3	
Partial safety factor	$\gamma_{Ms}^{1)}$	[-]	1.56					2.38			
<b>Steel failure with lever arm</b>											
Characteristic resistance, Steel grade 5.8	$M^0_{Rk,s}$	[Nm]	18.7	37.4	65.5	166.5	324.5	561.3	832.2	1125	
Characteristic resistance; Steel grade 8.8	$M^0_{Rk,s}$	[Nm]	30.0	59.8	104.8	266.4	519.3	898.0	1332	1799	
Partial safety factor	$\gamma_{Ms}^{1)}$	[-]	1.25								
Characteristic resistance; Steel grade 10.9	$M^0_{Rk,s}$	[Nm]	37.5	74.8	131.0	333.0	649.1	1123	1664	2249	
Partial safety factor	$\gamma_{Ms}^{1)}$	[-]	1.5								
Characteristic resistance, Stainless steel A4 and HCR, property class 50 (>M24) and 70 ( $\leq$ M24)	$M^0_{Rk,s}$	[Nm]	26.2	52.3	91.7	233.1	454.4	785.8	832.2	1125	
Partial safety factor	$\gamma_{Ms}^{1)}$	[-]	1.56					2.38			
<b>Concrete pry-out failure</b>											
Factor in equation (5.7) acc. 5.2.3.3 of TR 029 for Design of Bonded Anchors	k	[-]	2.0								
Partial safety factor	$\gamma_{Mp}^{1)}$ $\gamma_{Mc}$	[-]	2.1 <sup>2)</sup>					1.8 <sup>3)</sup>			
<b>Concrete edge failure</b>											
See section 5.2.3.4 of the Technical Report TR 029 for the Design of Bonded Anchors											
Partial safety factor	$\gamma_{Msp}^{1)}$	[-]	2.1 <sup>2)</sup>					1.8 <sup>3)</sup>			

1) In absence of other national regulations

2) The partial safety factor  $\gamma_2 = 1,4$  is included

3) The partial safety factor  $\gamma_2 = 1,2$  is included

**Simpson Strong-Tie®**  
**AT-HP Injection Mortar**

**Annex C2**

**Design method TR 029:**  
**Char. values of resistance to shear loads - Threaded rods**

**Table C3: Characteristic values of resistance to tension loads.**  
Design acc. **CEN/TS 1992-4-5**

Simpson Strong-Tie® AT-HP Injection Mortar			Threaded rod							
			M8	M10	M12	M16	M20	M24	M27	M30
<b>Steel failure</b>										
Characteristic resistance, Steel grade 5.8	$N_{Rk,s}$	[kN]	18.3	29	42.2	78.5	122.5	176.5	229.5	280.5
Characteristic resistance; Steel grade 8.8	$N_{Rk,s}$	[kN]	29.3	46.4	67.4	125.6	196	282.4	367.2	448.8
Partial safety factor	$\gamma_{Ms}^{1)}$	[-]	1.5							
Characteristic resistance; Steel grade 10.9	$N_{Rk,s}$	[kN]	36.6	58	84.3	157	245	353	459	561
Partial safety factor	$\gamma_{Ms}^{1)}$	[-]	1.4							
Characteristic resistance, Stainless steel A4 and HCR, property class 50 (>M24) and 70 ( $\leq$ M24)	$N_{Rk,s}$	[kN]	25.6	40.6	59	109.9	171.5	247.1	229.5	280.5
Partial safety factor	$\gamma_{Ms}^{1)}$	[-]	1.87							
<b>Combined pull-out and concrete cone failure</b>										
Nom. threaded rod diameter	d	[mm]	8	10	12	16	20	24	27	30
Characteristic bond resistance in <b>non-cracked</b> concrete C20/25										
Temperature range I: 40°C/24°C <sup>2)</sup>	$\tau_{Rk,ucr}$	[N/mm <sup>2</sup> ]	9.0	8.5	8.5	8.0	7.5	6.5	6.5	6.0
Temperature range II: 80°C/50°C <sup>2)</sup>	$\tau_{Rk,ucr}$	[N/mm <sup>2</sup> ]	7.0	6.5	6.5	6.0	5.5	5.0	5.0	4.5
Increasing factor for $\tau_{Rk}$ in non-cracked concrete	$\Psi_c$	C25/30	1.06							
		C30/37	1.12							
		C35/45	1.19							
		C40/50	1.23							
		C45/55	1.27							
		C50/60	1.30							
Partial safety factor	$\gamma_{Mp=1)}$ $\gamma_{Mc}$	[-]	2.1 <sup>3)</sup>				1.8 <sup>4)</sup>			
Factor acc. CEN/TS 1992-4-5, § 6.2.2.3	$k_{ucr}$	[-]	10.1							
<b>Concrete cone failure</b>										
Factor acc. CEN/TS 1992-4-5, § 6.2.3.1	$k_{ucr}$	[-]	10.1							
Edge distance	$C_{cr,N}$	[-]	1.5 $h_{ef}$							
Spacing	$S_{cr,N}$	[-]	3 $h_{ef}$							
<b>Splitting failure</b>										
Edge distance $C_{cr,sp}$ [mm]	$h/h_{ef} \geq 2.0$	1.0 $h_{ef}$								
	$2.0 > h/h_{ef} > 1.3$	4.6 $h_{ef}$ - 1.8 h								
	$h/h_{ef} \leq 1.3$	2.26 $h_{ef}$								
Center spacing (splitting)	$S_{cr,sp}$	[mm]	2 x $C_{cr,sp}$							
Partial safety factor	$\gamma_{Msp}^{1)}$	[-]	2.1 <sup>3)</sup>				1.8 <sup>4)</sup>			

<sup>1)</sup> In absence of other national regulations;

<sup>2)</sup> Maximum short and long term temperatures;

<sup>3)</sup> The partial safety factor  $\gamma_2 = 1.4$  is included

<sup>4)</sup> The partial safety factor  $\gamma_2 = 1.2$  is included

**Simpson Strong-Tie®**  
**AT-HP Injection Mortar**

**Annex C3**

Design **CEN/TS 1992-4-5**:

Char. values of resistance to tension loads - Threaded rods

**Table C4: Characteristic values of resistance to shear loads.**

Design acc. **CEN/TS 1992-4-5**

Simpson Strong-Tie® AT-HP Injection Mortar			Threaded rod							
			M8	M10	M12	M16	M20	M24	M27	M30
<b>Steel failure without lever arm</b>										
Characteristic resistance, Steel grade 5.8	$V_{Rk,s}$	[kN]	9.2	14.5	21.1	39.3	61.3	88.3	114.8	140.3
Characteristic resistance; Steel grade 8.8	$V_{Rk,s}$	[kN]	14.7	23.2	33.7	62.8	98	141.2	183.6	224.4
Partial safety factor	$\gamma_{Ms}^{1)}$	[-]	1.25							
Characteristic resistance; Steel grade 10.9	$V_{Rk,s}$	[kN]	18.3	29	42.2	78.5	122.5	176.5	229.5	280.5
Partial safety factor	$\gamma_{Ms}^{1)}$	[-]	1.5							
Ductility factor acc. CEN/TS 1992-4-5, § 6.3.2.1	$k_2$	[-]	0.8							
<b>Steel failure with lever arm</b>										
Characteristic resistance, Steel grade 5.8	$M^0_{Rk,s}$	[Nm]	18.7	37.4	65.5	166.5	324.5	561.3	832.2	1125
Characteristic resistance; Steel grade 8.8	$M^0_{Rk,s}$	[Nm]	30.0	59.8	104.8	266.4	519.3	898.0	1332	1799
Partial safety factor	$\gamma_{Ms}^{1)}$	[-]	1.25							
Characteristic resistance; Steel grade 10.9	$M^0_{Rk,s}$	[Nm]	37.5	74.8	131.0	333.0	649.1	1123	1664	2249
Partial safety factor	$\gamma_{Ms}^{1)}$	[-]	1.5							
<b>Concrete pry-out failure</b>										
Factor in equation (27) of CEN/TS 1992-4-5, § 6.3.3	$k_3$	[-]	2.0							
Partial safety factor	$\gamma_{Mc}^{1)}$	[-]	2.1 <sup>2)</sup>				1.8 <sup>3)</sup>			
<b>Concrete edge failure</b>										
Concrete Edge failure, see CEN/TS 1992-4-5, § 6.3.4										
Partial safety factor	$\gamma_{Mc}^{1)}$	[-]	2.1 <sup>2)</sup>				1.8 <sup>3)</sup>			

<sup>1)</sup> In absence of other national regulations

<sup>2)</sup> The partial safety factor  $\gamma_2 = 1,4$  is included

<sup>3)</sup> The partial safety factor  $\gamma_2 = 1,2$  is included

**Simpson Strong-Tie®  
AT-HP Injection Mortar**

Design **CEN/TS 1992-4-5**:

Char. values of resistance to shear loads - Threaded rods

**Annex C4**



**Table C5: Displacement under tension loads**

Simpson Strong-Tie® AT-HP with threaded rods			Threaded rod							
			M8	M10	M12	M16	M20	M24	M27	M30
Non-cracked concrete										
Temperature range I: 40°C / 24°C <sup>2)</sup>										
Displacement <sup>1)</sup>	$\delta_{N0}$	[mm/(N/mm <sup>2</sup> )]	0.02	0.03	0.03	0.03	0.03	0.04	0.04	0.05
	$\delta_{N\infty}$	[mm/(N/mm <sup>2</sup> )]	0.04	0.04	0.05	0.05	0.06	0.07	0.07	0.08
Temperature range II: 80°C / 50°C <sup>2)</sup>										
Displacement <sup>1)</sup>	$\delta_{N0}$	[mm/(N/mm <sup>2</sup> )]	0.10	0.11	0.12	0.13	0.15	0.17	0.18	0.19
	$\delta_{N\infty}$	[mm/(N/mm <sup>2</sup> )]	0.16	0.18	0.19	0.22	0.25	0.27	0.29	0.32

<sup>1)</sup> Calculation of the displacement for design load:

Displacement for short term load =  $\delta_{N0} \cdot [\tau_{Sd} / 1,4]$

Displacement for long term load =  $\delta_{N\infty} \cdot [\tau_{Sd} / 1,4]$  ( $\tau_{Sd}$  = design bond strength)

<sup>2)</sup> Maximum short and long term temperatures

**Table C6: Displacement under shear loads**

Simpson Strong-Tie® AT-HP with threaded rods			Threaded rod							
			M8	M10	M12	M16	M20	M24	M27	M30
Admissible service load : V [kN]			5.9	9.3	13.5	25.2	39.3	50.4	65.6	80.2
Displacement <sup>3)</sup>	$\delta_{V0}$	[mm/kN]	2.0	2.0	2.0	2.0	2.0	2.0	2.0	2.0
	$\delta_{V\infty}$	[mm/kN]	4.0	4.0	4.0	4.0	4.0	4.0	4.0	4.0

<sup>3)</sup> Calculation of the displacement for design load:

Displacement for short term load =  $\delta_{V0} \cdot [V_d / 1,4]$

Displacement for long term load =  $\delta_{V\infty} \cdot [V_d / 1,4]$

**Simpson Strong-Tie®  
AT-HP Injection Mortar**

**Displacements - Threaded rods**

**Annex C5**