

ZAGZAVOD ZA
GRADBENIŠTVO
SLOVENIJESLOVENIAN
NATIONAL BUILDING
AND CIVIL ENGINEERING
INSTITUTE

Član

Member of



www.eta.eu

Dimičeva 12,
1000 Ljubljana, Slovenija

Tel.: +386 (0)1 280 44 72, +386 (0)1-280 45 37

Fax: +386 (0)1 280 44 84

e-mail: info.ta@zag.si

http://www.zag.si

European Technical Assessment

ETA-13/0415
of 20.10.2017*English version prepared by ZAG*

General Part

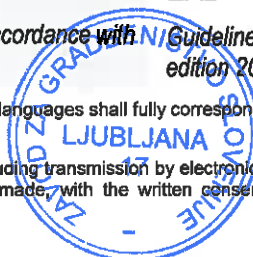
Organ za tehnično ocenjevanje, ki je izdal ETA
*Technical Assessment Body issuing the ETA***ZAG Ljubljana****Komercialno ime gradbenega proizvoda**
*Trade name of the construction product***POLY-GP masonry****Družina proizvoda, ki ji gradbeni proizvod
pripada****33: Kovinsko kemično sidro za
uporabo v zidovju***Product family to which the construction product belongs***33: Metal injection anchor for use in masonry****Proizvajalec**
*Manufacturer***SIMPSON STRONG-TIE® France**
Z.A.C. Des Quatre Chemins
85400 Sainte-Gemme-la-Plaine
France
www.simpson.fr**Proizvodni obrat**
*Manufacturing plant***SIMPSON STRONG-TIE**
173 Z.I. Les Mourgues
30350 Cardet
France**Ta Evropska tehnična ocena vsebuje****17 strani vključno s 14 prilogami, ki so
sestavni del te ocene***This European Technical Assessment contains***17 pages including 14 annexes, which form an integral
part of the document****Ta Evropska tehnična ocena je izdana na
podlagi Uredbe (EU) št. 305/2011 na osnovi****Smernice za evropska tehnična soglasja
ETAG 029, izdaja 2013, ki se uporablja kot
EAD***This European Technical Assessment is issued in accordance with Guideline for European Technical Approval ETAG 029,
regulation (EU) No 305/2011, on the basis of edition 2013, used as EAD**Translations of this European Technical Assessment in other languages shall fully correspond to the original issued document and should be identified as such.**Communication of this European Technical Assessment, including transmission by electronic means, shall be in full (excepted the confidential Annex(es) referred to above). However, partial reproduction may be made, with the written consent of the issuing Technical Assessment Body. Any partial reproduction has to be identified as such.*

Specific Part

1 Technical description of the product

The injection system POLY-GP masonry is a bonded anchor (injection type) consisting of a mortar cartridge with injection mortar POLY-GP, a perforated plastic sleeve and an anchor rod (with hexagon nut and washer) of sizes M8, M10 and M12. The steel elements are made of zinc coated steel or stainless steel.

The anchor rod is placed into a drilled hole/perforated plastic sleeve filled with the injection mortar and anchored through the bond between element, injection mortar and masonry.

An illustration and the description of the product are given in Annex A.

2 Specification of the intended use

The performances given in Chapter 3 are only valid if the anchor is used in compliance with the specifications and conditions given in Annex B.

The provisions made in this European Technical Assessment are based on an assumed working life of the anchor of 50 years. The indications given on the working life cannot be interpreted as a guarantee given by the manufacturer, but are to be regarded only as a means for choosing the right products in relation to the expected economically reasonable working life of the works.

3 Performance of the product and references to the methods used for this assessment

3.1 Mechanical resistance and stability (BWR 1)

The essential characteristics for mechanical resistance and stability are listed in Annexes C1 to C3.

3.2 Safety in case of fire (BWR 2)

Anchorage satisfies requirements for Class A1 relating to reaction to fire.
Resistance to fire is not assessed.

3.3 Hygiene, health and environment (BWR 3)

Regarding dangerous substances contained in this European Technical Assessment, there may be requirements applicable to the products falling within its scope (e.g. transported European legislation and national laws, regulations and administrative provisions). In order to meet provisions of the regulation (EU) No 305/2011, these requirements need also to be complied with, when they apply.

3.4 Safety in use (BWR 4)

For basic requirement safety in use the same criteria are valid as for basic requirement mechanical resistance and stability.

3.5 Protection against noise (BWR 5)

Not relevant.

3.6 Energy economy and heat retention (BWR 6)

Not relevant.

3.7 Sustainable use of natural resources (BWR 7)

For sustainable use of natural resources no performance was determined for this product.

3.8 General aspects relating to fitness for use

Durability and serviceability are only ensured if specifications of intended use according to Annexes B1 and B2 are kept.

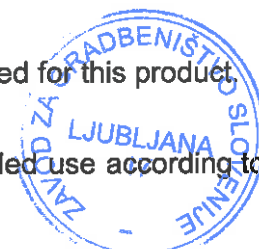



4 Assessment and verification of constancy of performance (AVCP)

According to the decision 97/177/EC of the European Commission¹ the system of assessment and verification of constancy of performance (AVCP) 1 apply.

5 Technical details necessary for the implementation of the AVCP system

Technical details necessary for the implementation of the AVCP system are laid down in the control plan deposited at ZAG Ljubljana.

Issued in Ljubljana on 20.10.2017

Signed by:

Franc Capuder, M.Sc., Research Engineer
 Head of Service of TAB

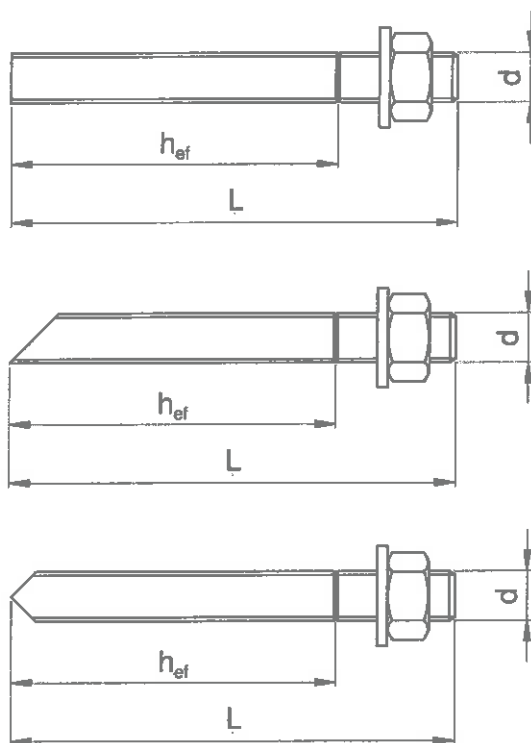

Anchor rods



Perforated plastic sleeve



Diameter of the sleeve: $d_s = 16$ mm
Length of the sleeve: $l_s = 85$ mm, 130 mm

POLY-GP masonry

Product description
Components of the anchor

Annex A1



Installation in solid masonry

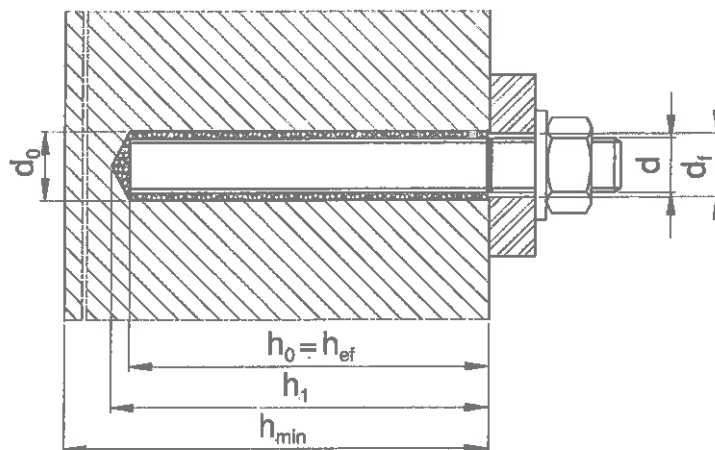

Installation in hollow or perforated masonry

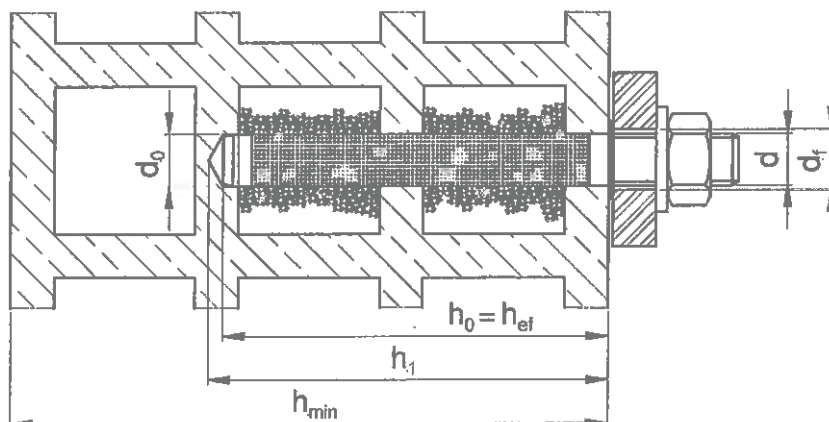

- d = diameter of the threaded rod
- d₀ = diameter of drill bit
- d_F = diameter of clearance hole in the fixture
- h_{ef} = effective anchorage depth
- h_{min} = minimum thickness of the base material
- h₁ = depth if drilled hole to deepest point

POLY-GP masonry

Product description
Installed condition

Annex A2



Mortar cartridges and applicator guns

Cartridge

Applicator gun

Coaxial cartridge:
380 ml

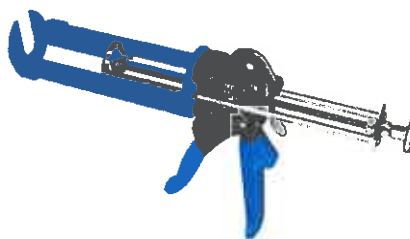

DT 380

Side by side cartridge:
345 ml



DT 345

Sausage cartridge:
300 ml



DT 300

Sausage cartridge:
170 ml



Mixing nozzles



MN1

MN4

MN9

MN20

POLY-GP masonry

Product description
Injection system

Annex A3



Table A1: Materials

Part		Material
1	Chemical mortar POLY-GP masonry	Polyester, blue/grey or green/beige ¹⁾
2	Perforated plastic sleeve	Polypropylene
3	Threaded rod	<p>Zinc electroplated steel $\geq 5 \mu\text{m}$ according to EN ISO 4042 (A2) Hot-dip galvanized steel $> 40 \mu\text{m}$ according to EN ISO 10684 Carbon steel property class 5.8 or 8.8 acc. to EN ISO 898-1 Stainless steel Stainless steel: 1.4362, 1.4401, 1.4404, 1.4439, 1.4571, 1.4578 according to EN 10088, property class 70 according to EN ISO 3506-1 Stainless steel – High corrosion resistance steel (HCR) Stainless steel: 1.4529, 1.4565 according to EN 10088, property class 70 according to EN ISO 3506-1 Commercial threaded rods with Inspection certificate 3.1 according to EN 10204:2004 and marking of embedment depth (this may be done by the manufacturer of the rod or by the worker on job site)</p>
4	Hexagon nut	<p>Zinc electroplated steel $\geq 5 \mu\text{m}$ according to EN ISO 4042 (A2) Hot-dip galvanized steel $> 40 \mu\text{m}$ according to EN ISO 10684 According to DIN 934 (EN ISO 4032), property class 8 according to EN ISO 898-2 Stainless steel According to DIN 934 (EN ISO 4032), property class 70 according to EN ISO 3506-2, Stainless steel: 1.4362, 1.4401, 1.4404, 1.4439, 1.4571, 1.4578 according to EN 10088 Stainless steel – High corrosion resistance steel (HCR) According to DIN 934 (EN ISO 4032), property class 70 according to EN ISO 3506-2, Stainless steel: 1.4529, 1.4565 according to EN 10088</p>
5	Washer	<p>Zinc electroplated steel $\geq 5 \mu\text{m}$ according to EN ISO 4042 (A2) Hot-dip galvanized steel $> 40 \mu\text{m}$ according to EN ISO 10684 According to DIN 125 (EN ISO 7089), DIN 440 (EN ISO 7094), DIN 9021 (EN ISO 7093) Stainless steel According to DIN 125 (EN ISO 7089), DIN 440 (EN ISO 7094), DIN 9021 (EN ISO 7093) Stainless steel: 1.4362, 1.4401, 1.4404, 1.4439, 1.4571, 1.4578 according to EN 10088 Stainless steel – High corrosion resistance steel (HCR) According to DIN 125 (EN ISO 7089), DIN 440 (EN ISO 7094), DIN 9021 (EN ISO 7093), Stainless steel: 1.4529, 1.4565 according to EN 10088</p>

¹⁾ The curing color proof works from +5°C

POLY-GP masonry

Product description
Materials

Annex A4



Specifications of intended use**Anchorage subjected to:**

- Static, quasi static load.

Base materials:

- Solid brick masonry (use category b), according to Annex B3.
- Hollow or perforated brick masonry (use category c), according to Annex B3.
- Autoclaved aerated concrete masonry (use category d), according to Annex B3.
- Mortar strength class of masonry M 2,5 at minimum according to EN 998-2:2016.
- For masonry made of other solid, hollow or perforated bricks, the characteristic resistance of the anchor may be determined by job site tests according to ETAG 029, Annex B under consideration of the β -factor according to Annex C2, Table C4.

Use conditions (Environmental conditions):

- The elements made of galvanized steel may be only used in structures subjected to dry internal conditions.
- The elements made of stainless steel may be used in structures subjected to dry internal conditions and also in structures subjected to external atmospheric exposure (including industrial and marine environment), or exposure in permanently damp internal conditions, if no particular aggressive conditions exist. Such particular aggressive conditions are e.g. permanent, alternating immersion of seawater or the splash zone of seawater, chloride atmosphere of indoor swimming pools or atmosphere with extreme chemical pollution (e.g. desulfurization plants or road tunnels where de-icing material are used).
- The elements made of high corrosion resistance stainless steel may be used in structures subjected to external atmospheric and permanently damp internal conditions, if other particular aggressive condition exists.

Temperature range:

- Service temperature range from -40°C to +80°C (maximum long term temperature +50°C and maximum short term temperature +80°C).

Design:

- Verifiable calculation notes and drawings are prepared taking account the relevant masonry in the region of the anchorage (nature and strength of the base materials), the loads to be transmitted and their transmission to the supports of the structure. The position of the anchor is indicated on the design drawings (e.g. position of the anchor relative to the supports etc.).
- The anchorages are designed in accordance with the ETAG 029 – Annex C “Metal injection anchors for use in masonry – design methods for anchorages”, Design Method A under the responsibility of an engineer experienced in anchorages and masonry work.

POLY-GP masonry**Intended use
Specifications****Annex B1**

Specifications of intended use - continuing**Installation:**

- Anchor installation carried out by appropriately qualified personnel under the supervision of the person responsible for technical matters on site.
- Use of the anchor only as supplied by the manufacturer without exchanging any component of the anchor.
- Anchor installation in accordance with the manufacturer's specifications and drawings using tools indicated in this European Technical Assessment.
- Commercial standard threaded rods, washers and hexagon nuts may also be used if the following requirements are fulfilled:
 - Material, dimensions and mechanical properties of the metal parts according to the specification given in Annex A4, Table A1 and Annexes B4 – B5, Tables B2 – B7,
 - Confirmation of material and mechanical properties of the metal parts by inspection certificate 3.1 according to EN 12024:2004, the documents should be stored,
 - Marking of the threaded rod with the envisage embedment depth. This may be done by the manufacturer of the rod or the person on job site.
- Checks before placing the anchor, to ensure that the characteristic values of the base material in which the anchor is to be placed, is identical with the values, which the characteristic loads apply for.
- Holes to be drilled perpendicular to the surface of the base material.
- In case of aborted hole the drill hole should be filled with mortar.
- Hole cleaning and anchor installation in accordance with the manufacturer's installation instructions (Annexes B6 and B7).
- Keeping the installation parameters (Annexes B4 and B5).
- Marking and keeping the effective anchorage depth.
- Keeping edge distance and spacing according to Annex C3 without minus tolerances.
- Observation of the curing time according to Annex B5, Table B8 until the anchor may be loaded.

POLY-GP masonry**Intended use
Specifications****Annex B2**

Table B1: Types of solid and hollow/perforated masonry

<p>Solid clay brick RT 307 according to EN 771-1 – HD</p>  <p>$f_b \geq 22 \text{ N/mm}^2$ $\rho \geq 1830 \text{ kg/m}^3$</p>	<p>Hollow clay brick RT 301– Type 1 according to EN 771-1 – LD</p>  <p>$f_b \geq 22 \text{ N/mm}^2$ $\rho \geq 1305 \text{ kg/m}^3$</p>	
<p>Hollow clay brick POROTON– Type 2 according to EN 771-1 – LD</p>  <p>$f_b \geq 8 \text{ N/mm}^2$ $\rho \geq 650 \text{ kg/m}^3$</p>	<p>Hollow clay brick LS BGV THERMO – Type 3 according to EN 771-1 – LD</p>  <p>$f_b \geq 6 \text{ N/mm}^2$ $\rho \geq 570 \text{ kg/m}^3$</p>	
<p>Concrete hollow block – Type 4 according to EN 771-3 – LD</p>  <p>$f_b \geq 4 \text{ N/mm}^2$ $\rho \geq 900 \text{ kg/m}^3$</p>	<p>Autoclaved aerated concrete block according to EN 771 – 4</p>  <p>$f_b \geq 3 \text{ N/mm}^2$ $\rho \geq 350 \text{ kg/m}^3$</p>	
<p>POLY-GP masonry</p>		<p>Annex B3</p>
<p>Intended use Type of bricks and dimensions</p>		



Table B2: Installation parameters of anchor rods for solid brick

		M8	M10	M12
Drill hole diameter	d_0 (mm)	10	12	14
Maximum clearance hole in the fixture	d_{fix} (mm)	9	12	14
Effective anchorage depth	h_{ef} (mm)	80		
Depth of the drilling hole	h_1 (mm)	85		
Installation torque moment	T_{inst} (Nm)	4	6	8

Table B3: Installation parameters of anchor rods for hollow brick type 1*

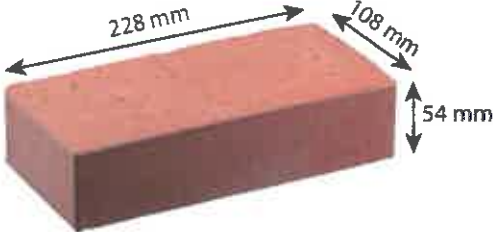
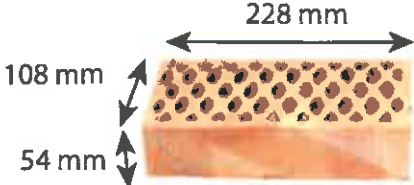
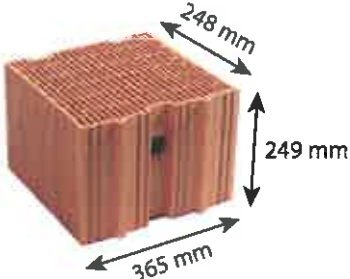
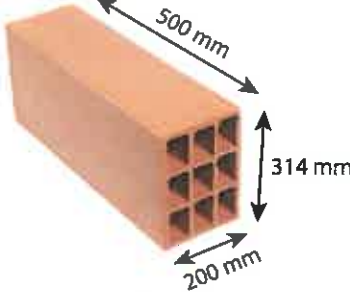
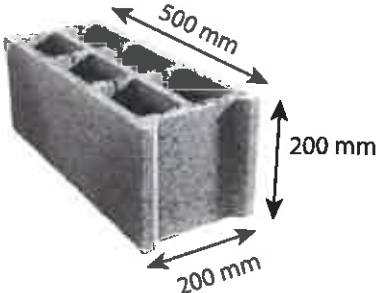
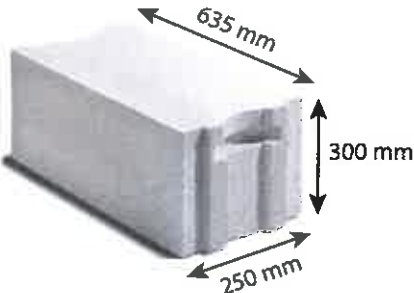
		M8	M10	M12
Drill hole diameter	d_0 (mm)	16		
Size of sleeve	$d_s \times l_s$ (mm)	16 x 85		
Maximum clearance hole in the fixture	d_{fix} (mm)	9	12	14
Effective anchorage depth	h_{ef} (mm)	85		
Depth of the drilling hole	h_1 (mm)	90		
Installation torque moment	T_{inst} (Nm)	4	6	6

Table B4: Installation parameters of anchor rods for hollow bricks type 2*

		M8	M10	M12
Drill hole diameter	d_0 (mm)	16		
Size of sleeve	$d_s \times l_s$ (mm)	16 x 130		
Maximum clearance hole in the fixture	d_{fix} (mm)	9	12	14
Effective anchorage depth	h_{ef} (mm)	130		
Depth of the drilling hole	h_1 (mm)	135		
Installation torque moment	T_{inst} (Nm)	4	6	6

Table B5: Installation parameters of anchor rods for hollow bricks type 3*

		M8	M10	M12
Drill hole diameter	d_0 (mm)	16		
Size of sleeve	$d_s \times l_s$ (mm)	16 x 130		
Maximum clearance hole in the fixture	d_{fix} (mm)	9	12	14
Effective anchorage depth	h_{ef} (mm)	130		
Depth of the drilling hole	h_1 (mm)	135		
Installation torque moment	T_{inst} (Nm)	4	6	6

* Type of bricks are detailed in the Annex B3

POLY-GP masonry	Annex B4
Intended use Installation parameters	



Table B6: Installation parameters of anchor rods for hollow concrete blocks type 4*

		M8	M10	M12
Drill hole diameter	d_0 (mm)	16		
Size of sleeve	$d_s \times l_s$ (mm)	16 x 130		
Maximum clearance hole in the fixture	d_{fix} (mm)	9	12	14
Effective anchorage depth	h_{ef} (mm)	130		
Depth of the drilling hole	h_1 (mm)	135		
Installation torque moment	T_{inst} (Nm)	4	6	8

* Type of bricks are detailed in the Annex B3

Table B7: Installation parameters of anchor rods for autoclaved aerated concrete

		M8	M10	M12
Drill hole diameter	d_0 (mm)	10	12	14
Maximum clearance hole in the fixture	d_{fix} (mm)	9	12	14
Effective anchorage depth	h_{ef} (mm)	80		
Depth of the drilling hole	h_1 (mm)	85		
Installation torque moment	T_{inst} (Nm)	2	3	5

Table B8: Maximum working time and maximum curing time for POLY-GP masonry chemical resin

Temperature of resin	Temperature of support	Working time	Curing time
+5°C	-5°C	25'	4h00'
+5°C	0°C	15'	3h00'
+5°C	+5°C	12'	2h30'
+10°C	+10°C	8'	1h15'
+15°C	+15°C	7'	55'
+20°C	+20°C	4'	30'
+30°C	+30°C	2'	20'

After the minimum curing time the blue injection mortar changes into grey and green coloured injection mortar changes into beige. The curing color proof works from +5°C.

POLY-GP masonry	Annex B5
Intended use Installation parameters	



Installation procedure for solid masonry

- 1 Drill hole to the required effective anchorage depth (h_{ef}) with a percussive/hammer drill using specified carbide drill bit diameter (d_0).



- 2 The hole shall be cleaned by at least 2 blowing operations, 2 brushing operations followed again by 2 blowing operations starting from the bottom of the hole. The brush shall have a sufficient resistance as it enters the drill hole. If this is not the case a new brush shall be used.



- 3 Remove the cap and install mixing nozzle.

Using sausage cartridges: Cut to open the sausage.



- 4 Load the cartridge into applicator gun.

- 5 Dispense and discard first part of resin until it is properly mixed (uniform color). 3 strokes at least are needed.

- 6 Fill up the hole approximately 2/3rd with mortar starting at the bottom of the cleaned drilled hole. Withdraw the nozzle slowly step by step after each trigger to avoid creating air pockets.

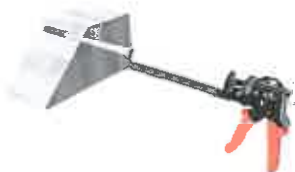

- 7 Insert a clean, oil free threaded rod, turning slowly until it touches the bottom of the hole or until to the marking of h_{ef} . Setting control: After the rod has been fully inserted to the marking of embedment depth, excess mortar flows out of the drilled hole. Clean excess resin.



- 8 Do not touch/move the threaded rod until mortar is fully cured. The curing time is given in Table B8. After required curing time the anchor can be loaded. Apply the installation torque T_{inst} using calibrated torque wrench.



POLY-GP masonry

Intended use
Installation instructions

Annex B6



Installation procedure for hollow/perforated masonry

- 1 Drill hole to the required depth (h_1) with a rotary drill using specified carbide drill bit diameter (d_0).



- 2 The hole shall be cleaned by at least 2 brushing operations. The brush shall have a sufficient resistance as it enters the drill hole. If this is not the case a new brush shall be used.



- 3 Insert the sleeve into the hole.



Remove the cap and install mixing nozzle.
Using sausage cartridges: Cutting to open the sausage.



- 4 Load the cartridge into applicator gun.
5 Dispense and discard first part of resin until it is properly mixed (uniform color). 3 strokes at least are needed.
6 Place the mixer at the bottom of the sleeve and inject the mortar as long as the sleeve is completely filled. Withdraw the nozzle slowly step by step after each trigger.

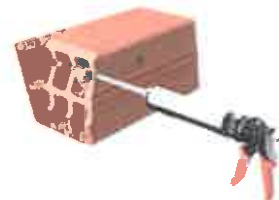

- 7 Insert a clean, oil free threaded rod, turning slowly until it touches the bottom of the sleeve. Clean excess resin.



- 8 Do not touch/move the threaded rod until mortar is fully cured. The curing time is given in Table B8. After required curing time the anchor can be loaded. Apply the installation torque T_{inst} using calibrated torque wrench.



POLY-GP MASONRY

Intended use
Installation instructions

Annex B7



Table C1: Characteristic tension and shear resistance

Brick type	Brick parameters: Density ρ (kg/m ³) Compressive strength f_b (N/mm ²)	Sleeve size (mm)	Anchor size	N_{Rk} ¹⁾ (kN)	V_{Rk} ²⁾ (kN)
Solid clay brick RT 307 according to EN 771-1 HD	$\rho \geq 1830$ $f_b = 22$	/	M8	2,5	2,5
			M10	2,5	2,5
			M12	2,5	2,5
Hollow clay brick RT 301 – Type 1 according to EN 771-1 LD	$\rho \geq 1305$ $f_b = 22$	16 x 85	M8	1,5	1,5
			M10	1,5	1,5
			M12	1,5	1,5
Hollow clay brick POROTON – Type 2 according to EN 771-1 LD	$\rho \geq 650$ $f_b = 8$	16 x 130	M8	1,5	1,5
			M10	1,2	1,2
			M12	2,0	2,0
Hollow clay brick LS BGV THERMO – Type 3 according to EN 771-1 LD	$\rho \geq 570$ $f_b = 6$	16 x 130	M8	1,5	1,5
			M10	1,5	1,5
			M12	2,0	2,0
Hollow concrete block BLOCS CREUX – Type 4 according to EN 771-3 LD	$\rho \geq 900$ $f_b = 4$	16 x 130	M8	1,5	1,5
			M10	2,0	2,0
			M12	2,0	2,0
Autoclaved aerated concrete EN 771-4	$\rho \geq 350$ $f_b = 3$	/	M8	0,9	0,9
			M10	1,2	1,2
			M12	1,2	1,2
Partial safety factor $\gamma_M = 2,5$ ³⁾					

¹⁾ For design according to ETAG 029, Annex C: $N_{Rk} = N_{Rk,p} = N_{Rk,b} = N_{Rk,pb} = N_{Rk,s}$

²⁾ For design according to ETAG 029, Annex C: $V_{Rk} = V_{Rk,b} = V_{Rk,c} = V_{Rk,s}$

³⁾ In absence of other national regulations

POLY-GP masonry

Performances
Characteristic tension and shear resistance

Annex C1



Table C2: Characteristic bending moments

Size			M8	M10	M12
Characteristic bending moment for threaded steel rod grade 5.8	$M_{Rk,s}$	(Nm)	20	39	68
Partial safety factor	γ_{Ms}	(-)	1,25		
Characteristic bending moment for threaded steel rod grade 8.8	$M_{Rk,s}$	(Nm)	30	60	105
Partial safety factor	γ_{Ms}	(-)	1,25		
Characteristic bending moment for threaded stainless rod A4-70	$M_{Rk,s}$	(Nm)	26	52	92
Partial safety factor	γ_{Ms}	(-)	1,56		

Table C3: Displacement under tension and shear load

	F (kN)	δ_{N0} (mm)	$\delta_{N\infty}$ (mm)	δ_{V0} (mm)	$\delta_{V\infty}$ (mm)
Solid brick	$N_{Rk} / (1.4 \cdot \gamma_M)$	0,41	0,82	0,71	1,07
Hollow/perforated clay/concrete brick		0,57	1,14	1,42	2,13
Autoclaved aerated concrete		0,64	1,28	0,97	1,45

Table C4: β -factors for job site tests according to ETAG 029 – Annex B

Brick type	β -factor
Solid and hollow/perforated brick EN 771-1, EN 771-3	0,86
Autoclaved aerated concrete EN 771-4	0,76

POLY-GP masonry
Performances
 Characteristic bending moment, displacements, β -factor
Annex C2

Table C5: Edge distances and spacings

	S_{cr} (mm)	C_{cr} (mm)	S_{min} (mm)	C_{min} (mm)
Solid brick	20 x d	10 x d	50	50
Hollow/perforated clay/concrete brick	l_{unit}	$0.5 \times l_{unit}$	100	100
Autoclaved aerated concrete	20 x d	10 x d	50	50

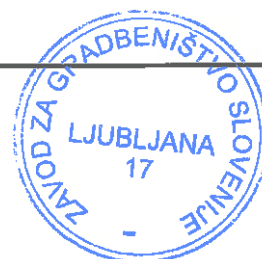
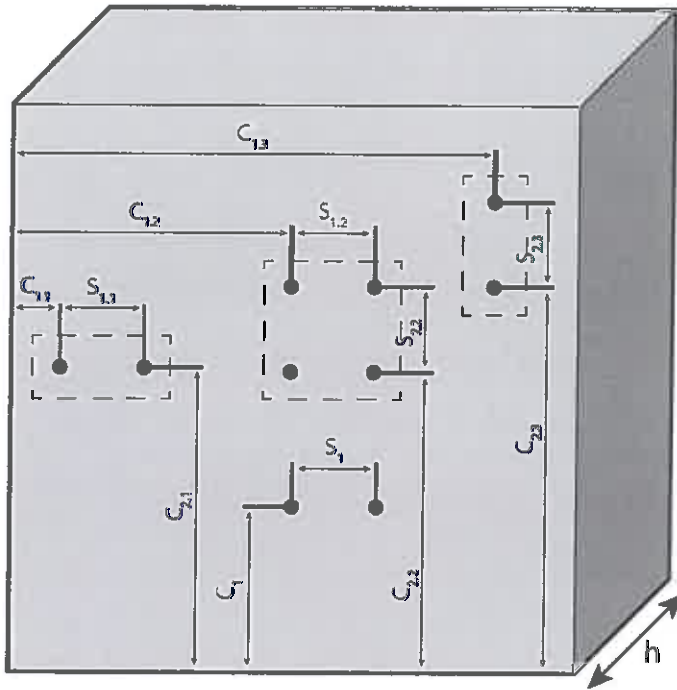

- d = nominal diameter of threaded rod
- l_{unit} = maximum dimension of masonry unit
- h = thickness of masonry

POLY-GP masonry

Performances
Edge distances and spacing

Annex C3

